

Thyristor Modules

$I_{TRMS} = 2x340 \text{ A}$
 $I_{TAVM} = 2x196 \text{ A}$
 $V_{RRM} = 1400-1800 \text{ V}$

V_{RSM}	V_{RRM}	Type
V_{DSM}	V_{DRM}	
V	V	
1500	1400	MCC 200-14io1 MCD 200-14io1
1700	1600	MCC 200-16io1 MCD 200-16io1
1900	1800	MCC 200-18io1 MCD 200-18io1

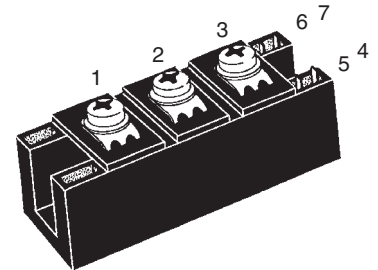
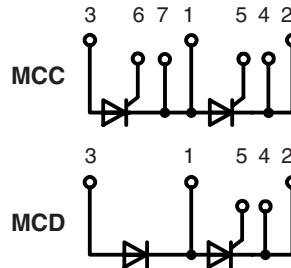

Symbol	Conditions	Maximum Ratings	
I_{TRMS}/I_{FRMS}	$T_{VJ} = T_{VJM}$	340	A
I_{TAVM}/I_{FAVM}	$T_C = 90^\circ\text{C}; 180^\circ \text{ sine}$	196	A
	$T_C = 85^\circ\text{C}; 180^\circ \text{ sine}$	216	A
I_{TSM}/I_{FSM}	$T_{VJ} = 45^\circ\text{C}; V_R = 0$	t = 10 ms (50 Hz), sine t = 8.3 ms (60 Hz), sine	8000 A 8600 A
	$T_{VJ} = T_{VJM}; V_R = 0$	t = 10 ms (50 Hz), sine t = 8.3 ms (60 Hz), sine	7000 A 7500 A
$\int i^2 dt$	$T_{VJ} = 45^\circ\text{C}; V_R = 0$	t = 10 ms (50 Hz), sine t = 8.3 ms (60 Hz), sine	320 000 A ² s 311 000 A ² s
	$T_{VJ} = T_{VJM}; V_R = 0$	t = 10 ms (50 Hz), sine t = 8.3 ms (60 Hz), sine	245 000 A ² s 236 000 A ² s
$(di/dt)_{cr}$	$T_{VJ} = T_{VJM}; f = 50\text{Hz}; t_p = 200\mu\text{s}; V_D = 2/3 V_{DRM}; I_G = 0.5 \text{ A}; di_G/dt = 0.5 \text{ A}/\mu\text{s}$	repetitive; $I_T = 500 \text{ A}$	100 A/ μs
		non repetitive; $I_T = 500 \text{ A}$	500 A/ μs
$(dv/dt)_{cr}$	$T_{VJ} = T_{VJM}; V_{DR} = 2/3 V_{DRM}; R_{GK} = \infty; \text{method 1 (linear voltage rise)}$		1000 V/ μs
P_{GM}	$T_{VJ} = T_{VJM}; t_p = 30 \mu\text{s}; I_T = I_{TAVM}; t_p = 500 \mu\text{s}$		120 W 60 W
P_{GAV}			20 W
V_{RGM}			10 V
T_{VJ}			-40...+125 °C
T_{VJM}			125 °C
T_{stg}			-40...+125 °C
V_{ISOL}	50/60 Hz, RMS; $I_{ISOL} \leq 1 \text{ mA};$	t = 1 min t = 1 s	3000 V~ 3600 V~
M_d	Mounting torque (M6) Terminal connection torque (M6)		2.25-2.75/20-25 Nm/lb.in. 4.5-5.5/40-48 Nm/lb.in.
Weight	Typical including screws		125 g

Features

- International standard package
- Direct copper bonded Al₂O₃ -ceramic base plate
- Planar passivated chips
- Isolation voltage 3600 V~
- UL registered, E 72873
- Keyed gate/cathode twin pins

Applications

- Motor control
- Power converter
- Heat and temperature control for industrial furnaces and chemical processes
- Lighting control
- Contactless switches

Advantages

- Space and weight savings
- Simple mounting
- Improved temperature and power cycling
- Reduced protection circuits

Data according to IEC 60747 and refer to a single thyristor/diode unless otherwise stated.

IXYS reserves the right to change limits, test conditions and dimensions

© 2004 IXYS All rights reserved

Symbol	Conditions	Characteristic Values
I_{RRM}, I_{DRM}	$T_{VJ} = T_{VJM}; V_R = V_{RRM}; V_D = V_{DRM}$	15 mA
V_T/V_F	$I_T, I_F = 200 \text{ A}; T_{VJ} = 25^\circ\text{C}$	1.20 V
V_{T0}	For power-loss calculations only ($T_{VJ} = 125^\circ\text{C}$)	0.8 V
r_T		1.0 mΩ
V_{GT}	$V_D = 6 \text{ V}; T_{VJ} = 25^\circ\text{C}$	2 V
	$T_{VJ} = -40^\circ\text{C}$	3 V
I_{GT}	$V_D = 6 \text{ V}; T_{VJ} = 25^\circ\text{C}$	150 mA
	$T_{VJ} = -40^\circ\text{C}$	220 mA
V_{GD}	$T_{VJ} = T_{VJM}; V_D = \frac{2}{3} V_{DRM}$	0.25 V
I_{GD}		10 mA
I_L	$T_{VJ} = 25^\circ\text{C}; t_p = 30 \mu\text{s}; V_D = 6 \text{ V}$ $I_G = 0.5 \text{ A}; di_G/dt = 0.5 \text{ A}/\mu\text{s}$	200 mA
I_H	$T_{VJ} = 25^\circ\text{C}; V_D = 6 \text{ V}; R_{GK} = \infty$	150 mA
t_{gd}	$T_{VJ} = 25^\circ\text{C}; V_D = \frac{1}{2} V_{DRM}$ $I_G = 0.5 \text{ A}; di_G/dt = 0.5 \text{ A}/\mu\text{s}$	2 μs
t_q	$T_{VJ} = T_{VJM}; I_T = 300 \text{ A}, t_p = 200 \mu\text{s}; -di/dt = 10 \text{ A}/\mu\text{s}$ typ. $V_R = 100 \text{ V}; dv/dt = 50 \text{ V}/\mu\text{s}; V_D = \frac{2}{3} V_{DRM}$	200 μs
Q_S	$T_{VJ} = T_{VJM}; I_T = 300 \text{ A}, -di/dt = 50 \text{ A}/\mu\text{s}$	550 μC
I_{RM}		235 A
R_{thJC}	per thyristor; DC current	0.13 K/W
	per module	0.065 K/W
R_{thJH}	per thyristor; DC current	0.18 K/W
	per module	0.09 K/W
d_s	Creepage distance on surface	12.7 mm
d_A	Strike distance through air	9.6 mm
a	Maximum allowable acceleration	50 m/s ²

Optional accessories for modules

Keyed gate/cathode twin plugs with wire length = 350 mm, gate = yellow, cathode = red

Type **ZY 180L** (L = Left for pin pair 4/5) } UL 758, style 1385,

Type **ZY 180R** (R = right for pin pair 6/7) } CSA class 5851, guide 460-1-1

Dimensions in mm (1 mm = 0.0394")

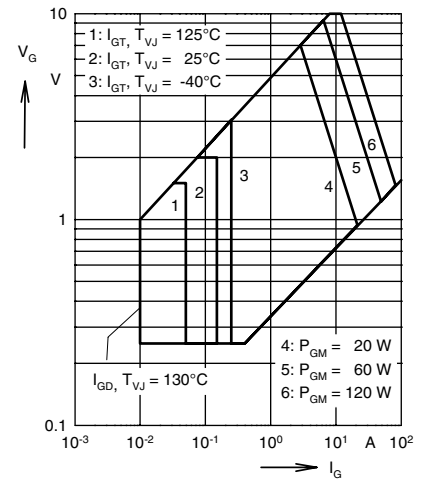
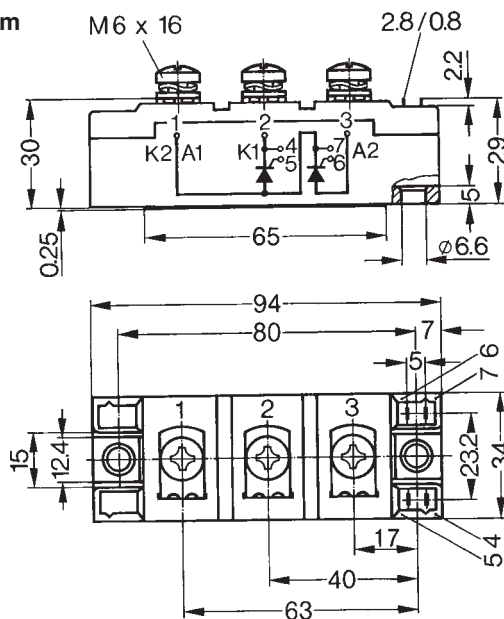

Fig. 1 Gate trigger characteristics

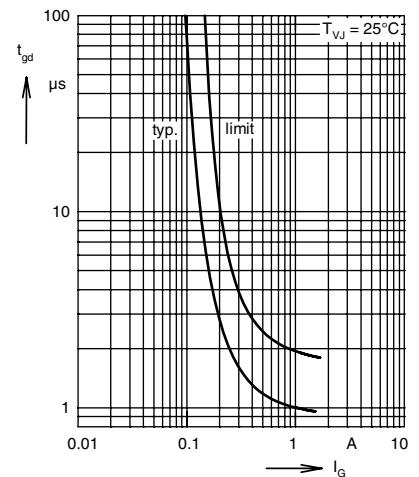

Fig. 2 Gate trigger delay time

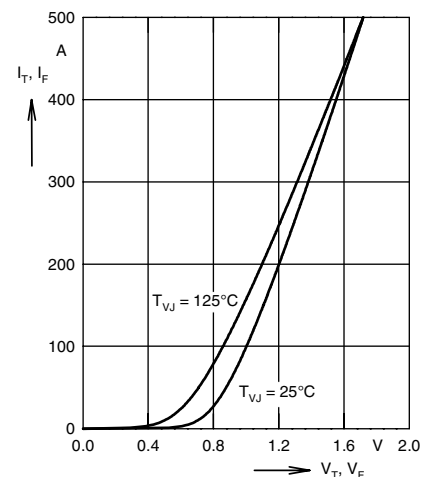

Fig. 3 Forward current versus voltage drop

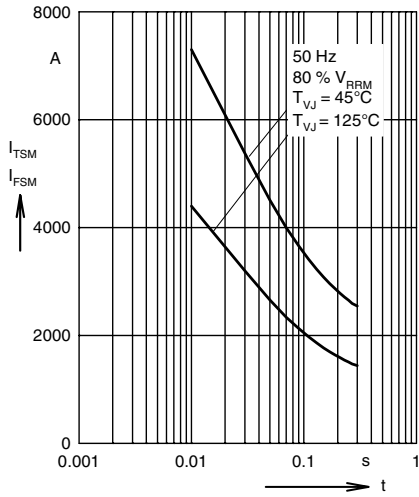

Fig. 4 Surge overload current
 I_{TSM}/I_{FSM} : Crest value, t: duration

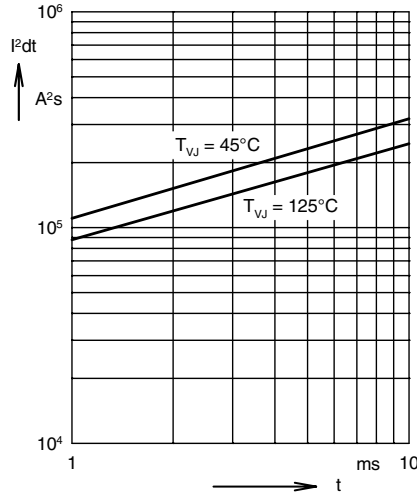

Fig. 5 I^2dt versus time (1-10 ms)

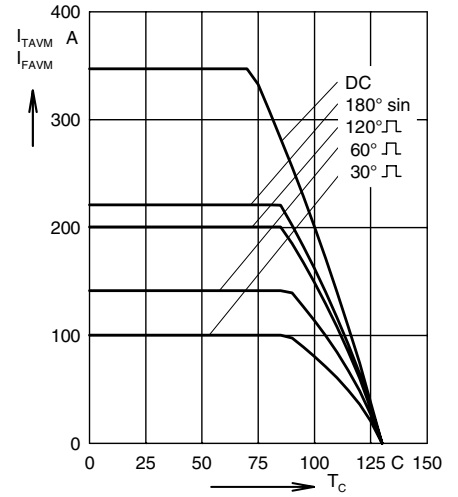

Fig. 6 Maximum forward current at case temperature

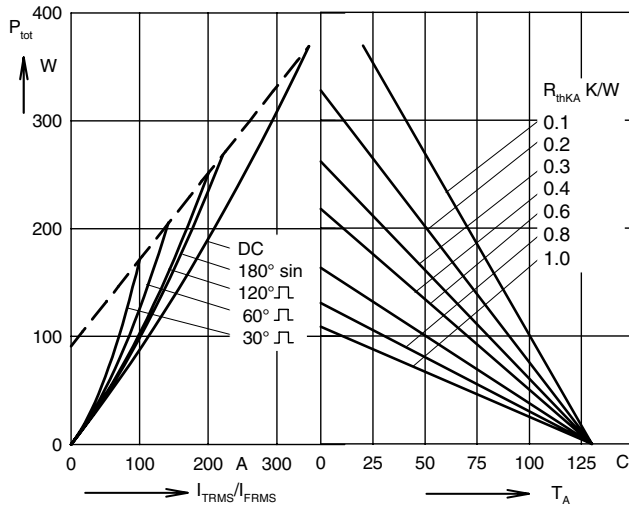

Fig. 7 Power dissipation versus on-state current and ambient temperature (per thyristor or diode)

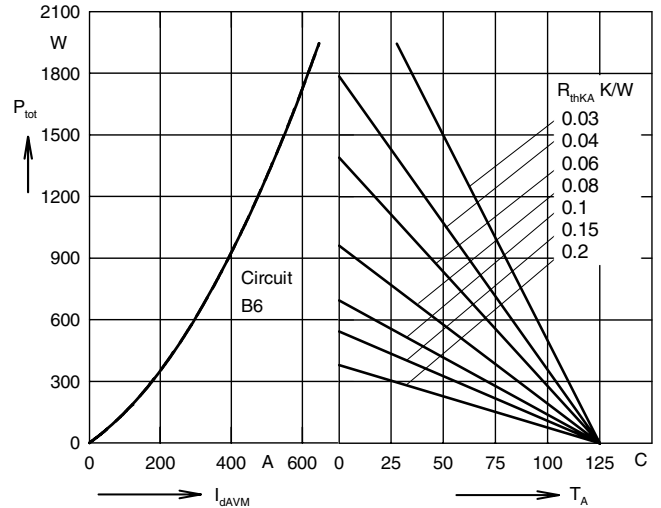

Fig. 8 3~ rectifier bridge: Power dissipation versus direct output current and ambient temperature

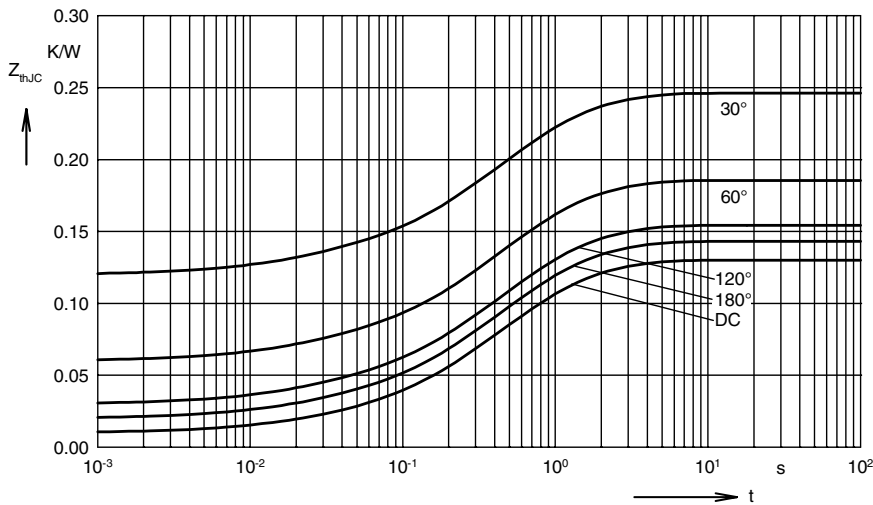

Fig. 9 Transient thermal impedance junction to case at various condition angles (per thyristor or diode)

Constants for Z_{thJC} calculation (DC):

i	R_{thi} (K/W)	t_i (s)
1	0.01	0.00014
2	0.0065	0.019
3	0.025	0.18
4	0.0615	0.52
5	0.027	1.6